

Date	Alteration	Index
9/1-04	Spiro pipe Ø=100 mm added	E

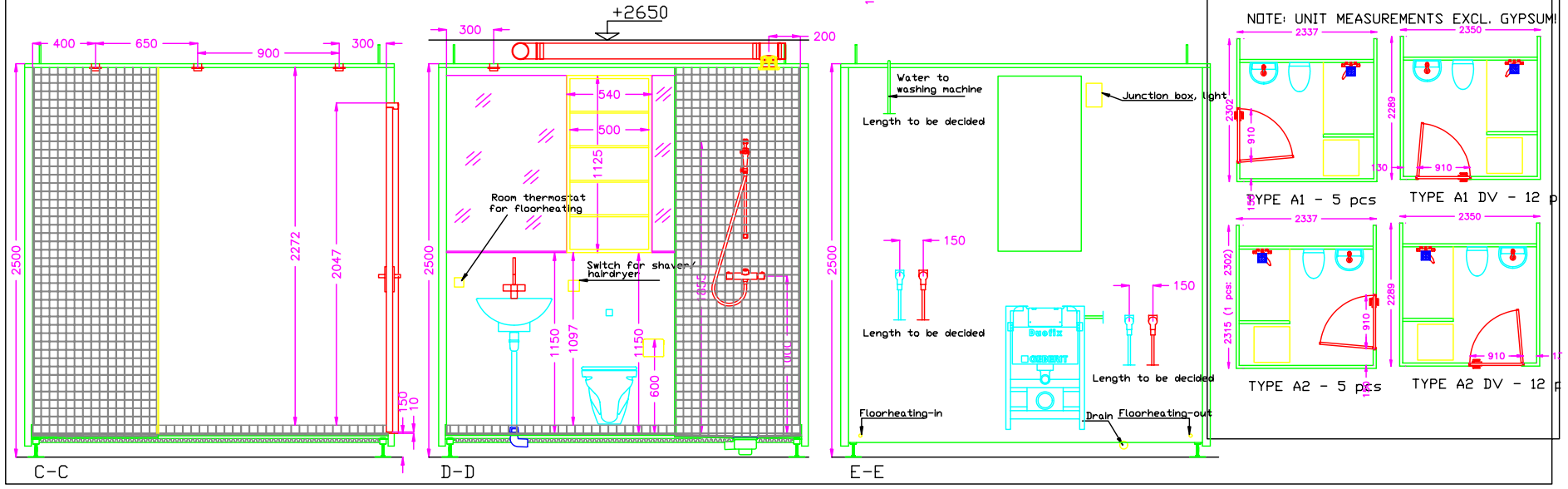

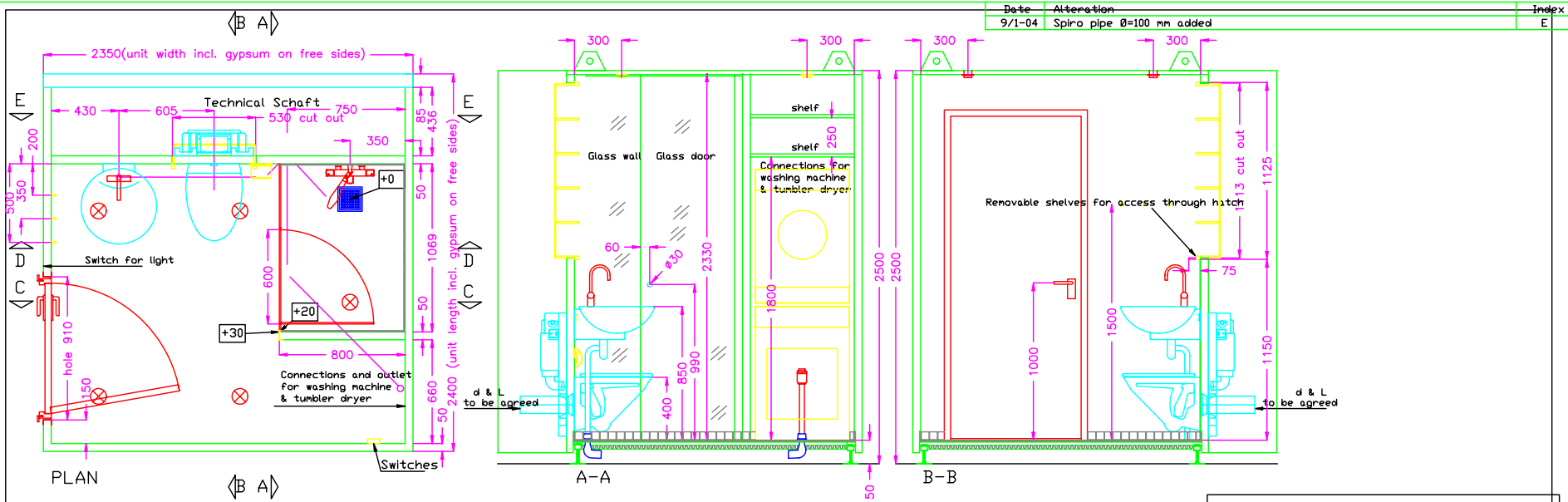
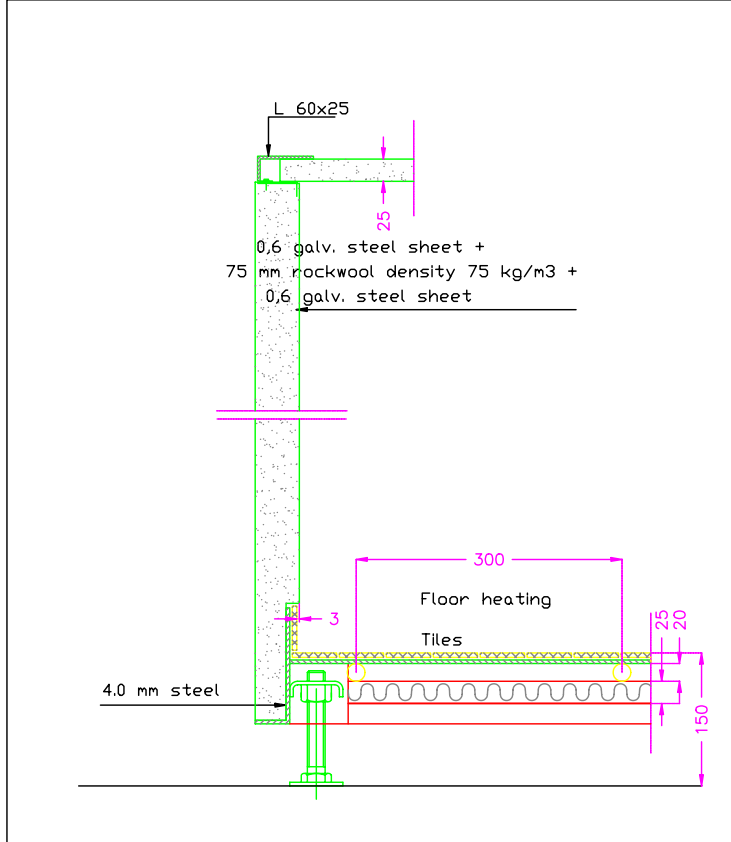

DESIGN & DEVELOPMENT A/S

KAPTAJN BERTELSSENSVEJ 19 • DK- 7120 VEJLE • DENMARK • PHONE +4575815444 • TELEFAX +4575815244

Pos no	Material description
1	Block stacked minerale wool 75 kg / m <sup>2</sup>
2	0.6 mm. galv. steel sheet
3	Mastic filler
4	Filler for leveling joints
5	Epoxy filler
6	Glue for tiles

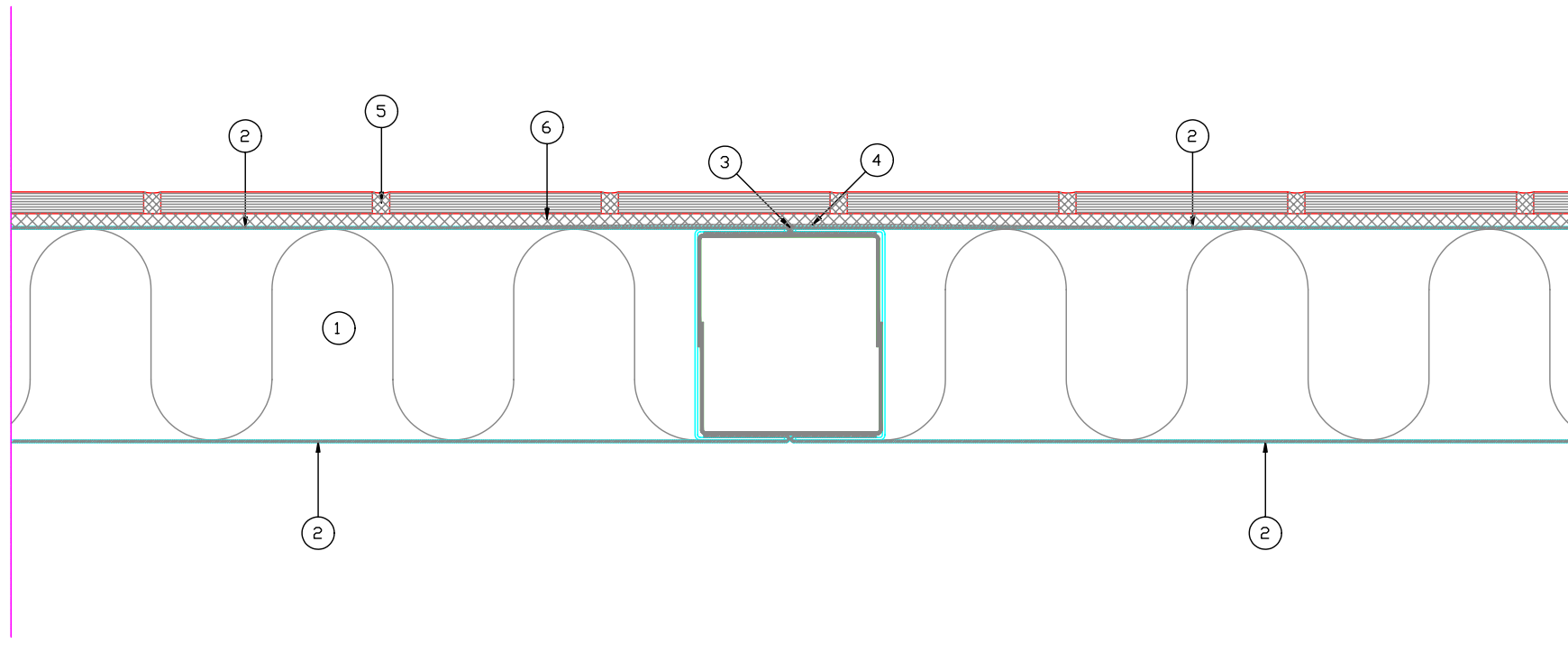

Date									
Index									
Send to									



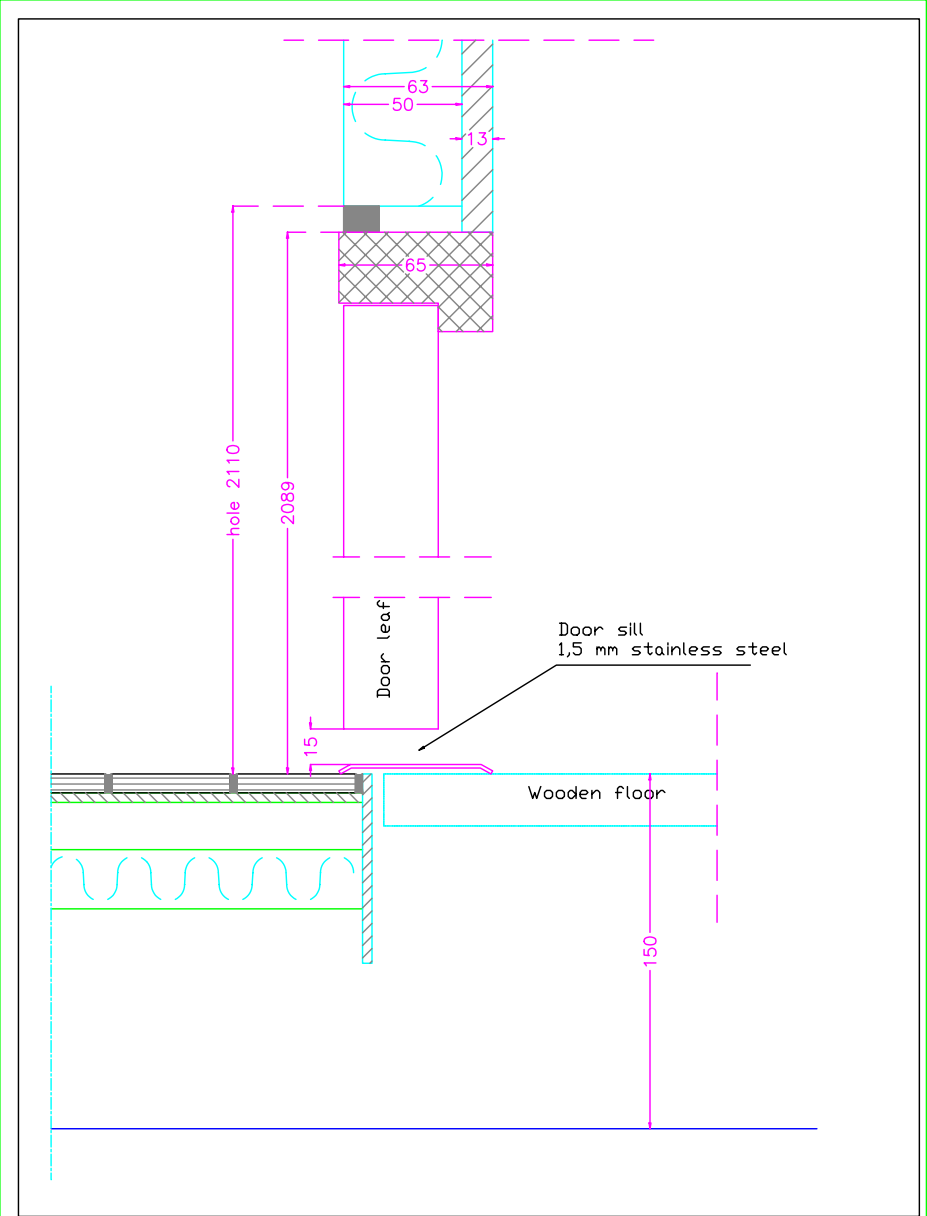

DESIGN & DEVELOPMENT A/S

KAPTAJN BERTELSENSVEJ 19 \* DK- 7120 VEJLE \* DENMARK \* PHONE +4575815444 \* TELEFAX +4575815244

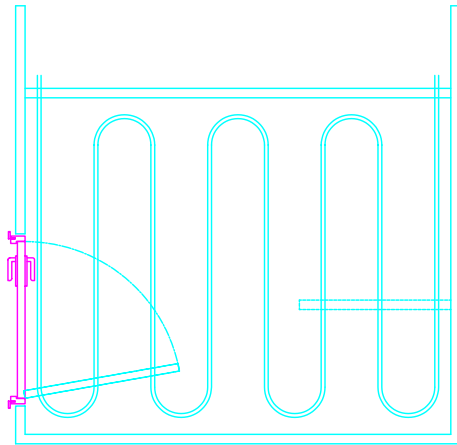

Floor heating Type A

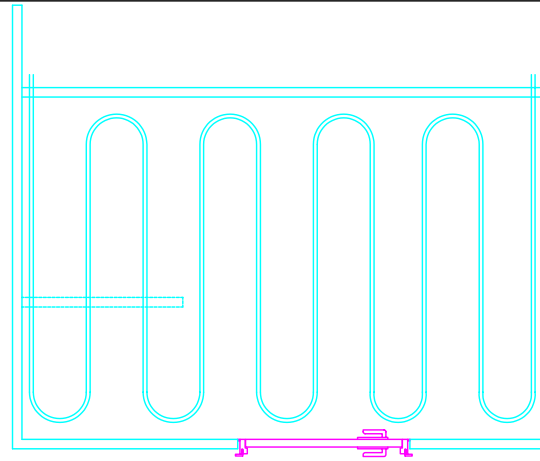

Floor heating Type B

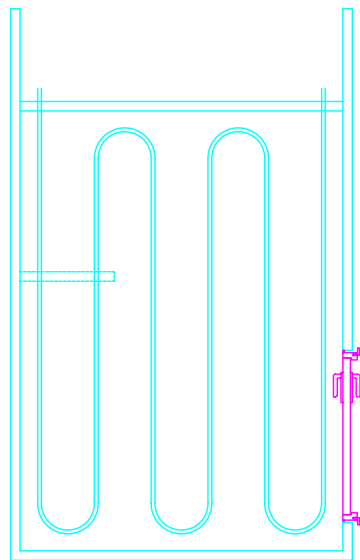

Floor heating Type T

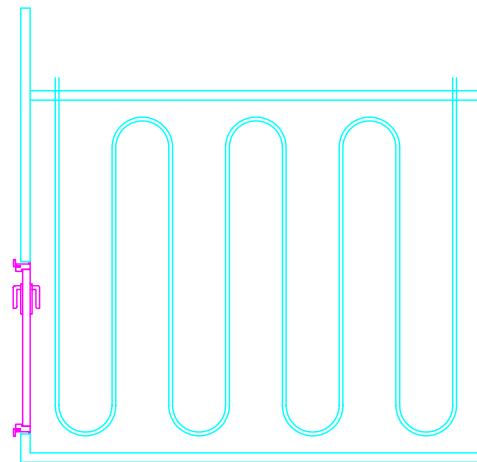

Floor heating Type H



DESIGN & DEVELOPMENT A/S

KAPTAJN BERTELSENSVEJ 19 \* DK- 7120 VEJLE \* DENMARK \* PHONE +4575815444 \* TELEFAX +4575815244

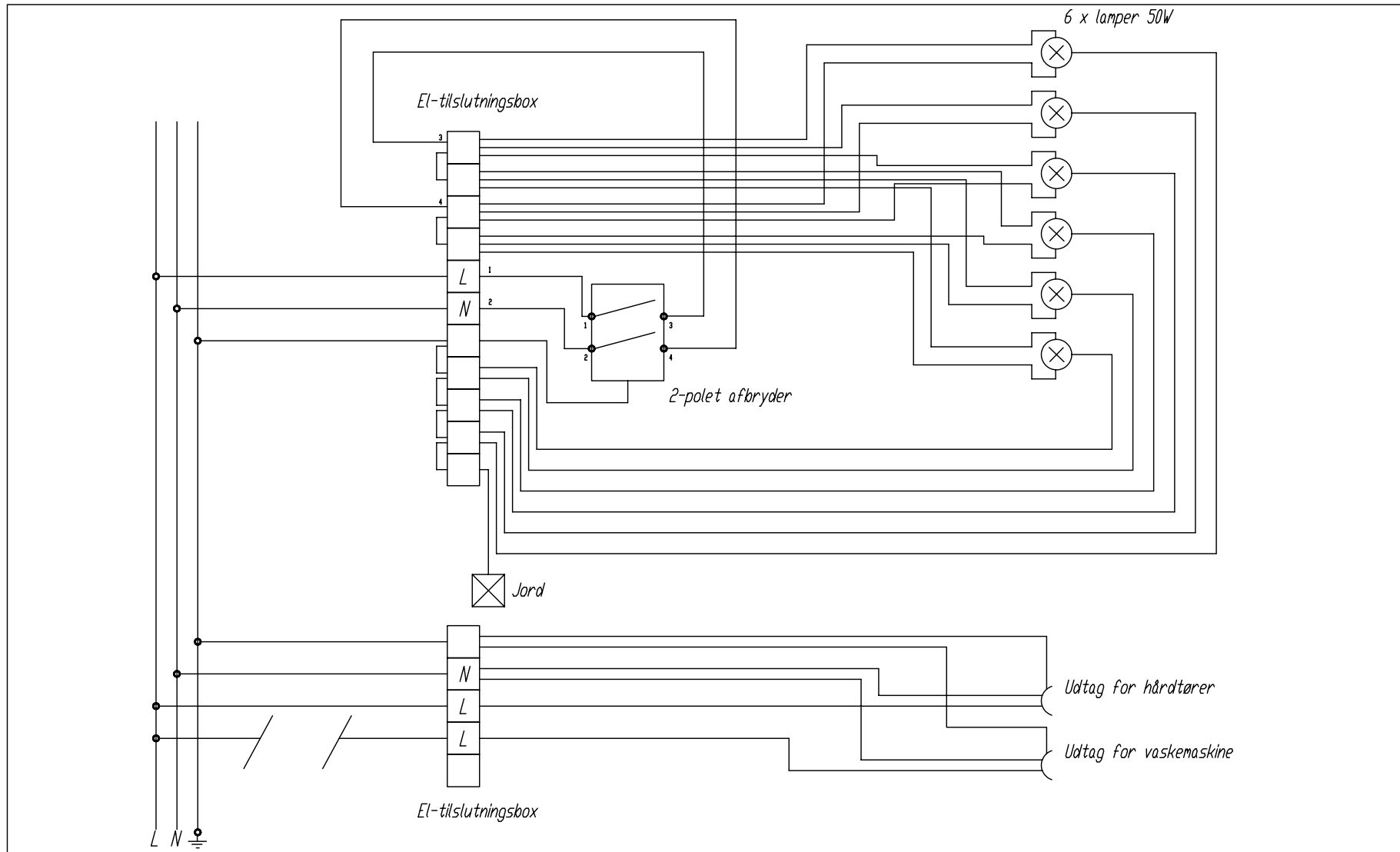

Date	26/2-04									
Index	/									
Send to	Skanska (PS)									

